

# Nevada/Vegas sch +3-s+divan assembly ARM A

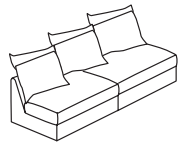

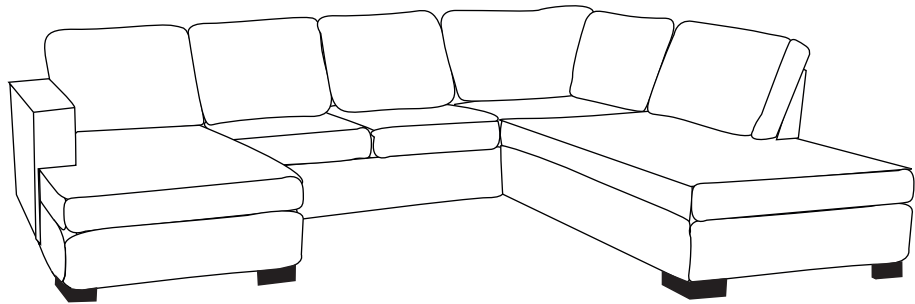

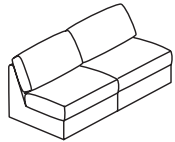



Vegas

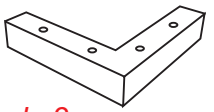
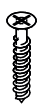

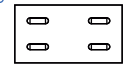

Nevada

## Components - Fittings

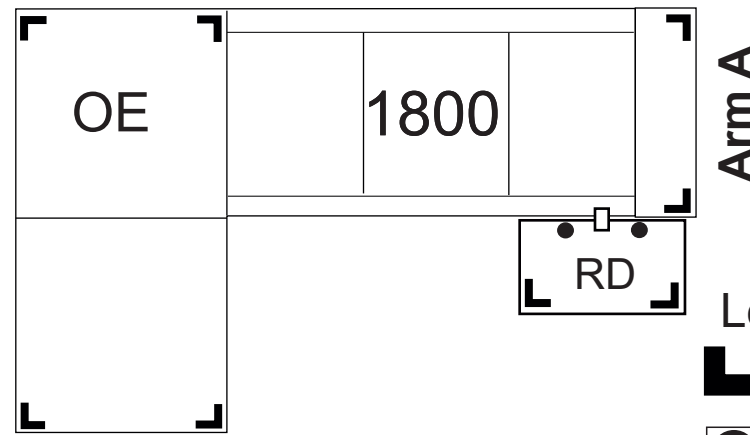
<p><b>A</b> 8 x</p>  <p><i>Note: use only 3 screws in each leg!</i></p>	<p><b>B</b> 24 x</p>  <p>M5*50</p>	<p><b>C</b> 26 x</p> <p>∅27</p>  <p>Felt</p>	<p><b>D</b> 2 x</p>  <p>H60</p>
<p><b>E</b> 2 x</p>  <p>M5*30</p>	<p><b>F</b> 4 x</p>  <p>M6*30</p>	<p><b>G</b> 1 x</p> 	<p><b>H</b> 1 x</p> 



- Legs symbols
-  - (A)+(B)+(C)
  -  - (D)+(E)+(C)

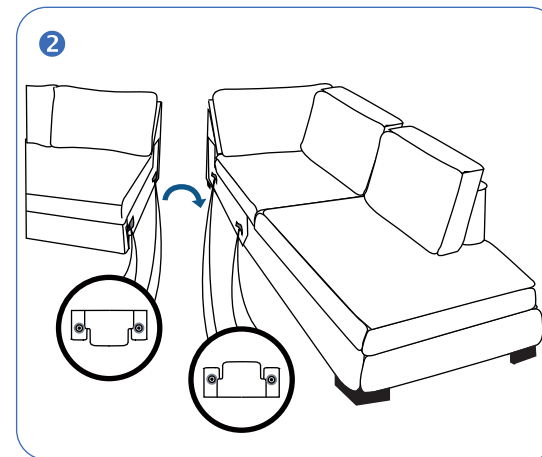
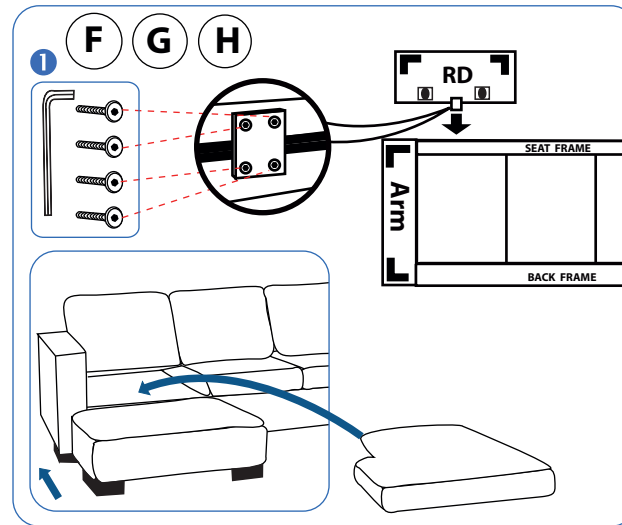

# Nevada/Vegas sch +3-s+divan assembly ARM B

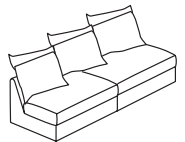
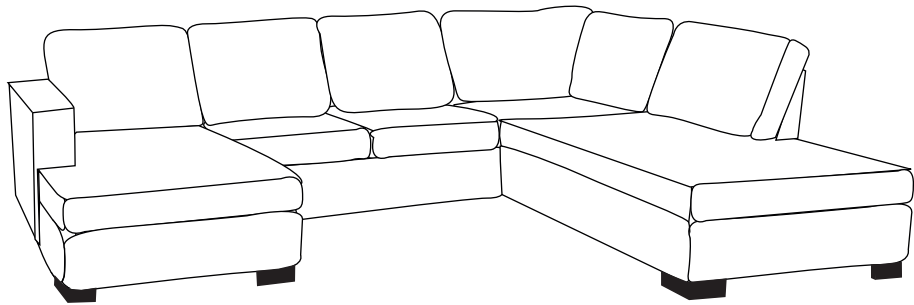

Vegas

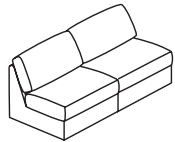

Nevada

## Components - Fittings

<p><b>A</b></p> <p>10 x </p>	<p><b>B</b></p> <p>10 x  M5*50</p>	<p><b>C</b></p> <p>10 x  Felt Ø27</p>	<p><b>D</b></p> <p>4 x </p>	<p><b>E</b></p> <p>1 x </p>
<p><b>F</b></p> <p>1 x </p>				

